

REVISIONS				
ZONE	REV	DESCRIPTION	DATE	APPROVED

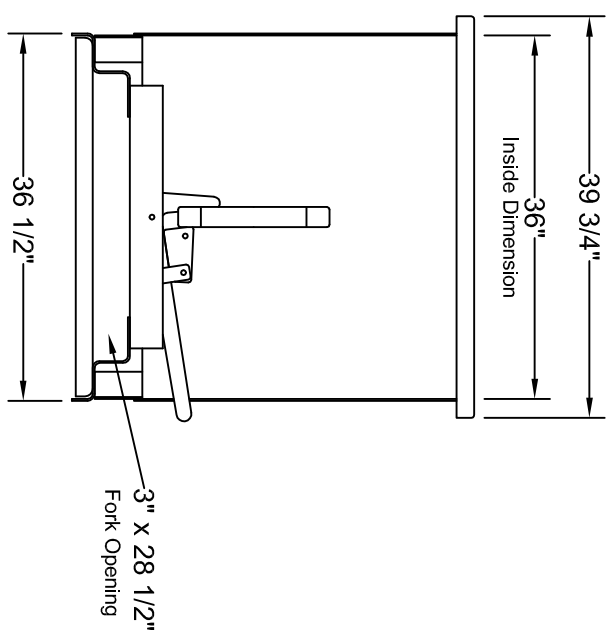

Note: All dimensions are approximate some dimensions may vary slightly per hopper

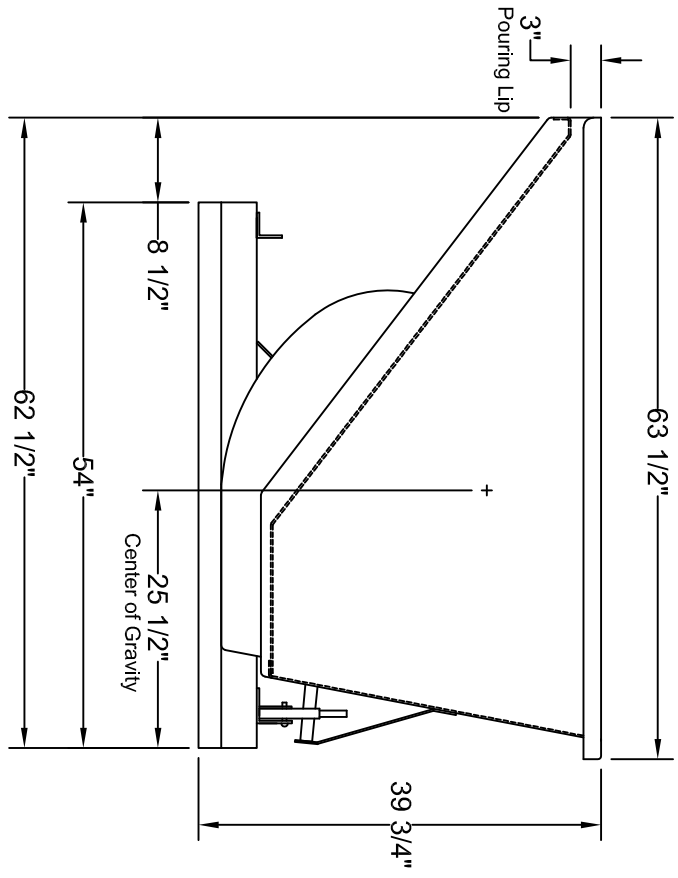
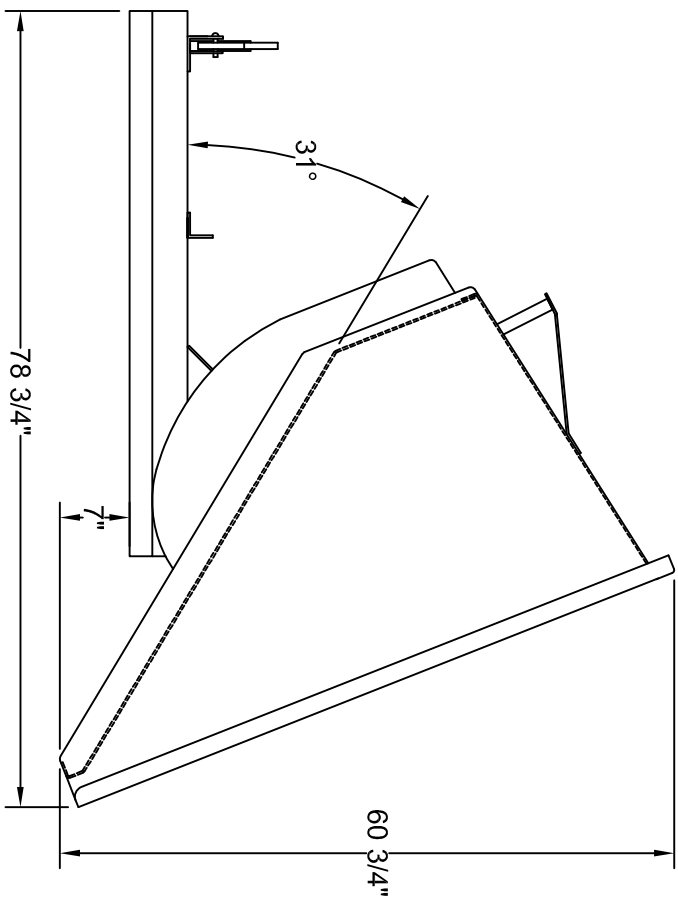

McCullough Ind., Inc.

1 yd Hopper Basic Dimensions

UNLESS OTHERWISE SPECIFIED: DIMENSIONS ARE IN INCHES DECIMALS ± .050 ANGULAR ± 0.5 DO NOT SCALE DRAWING		DATE
DRAWN		
CHECKED		
DESIGN		
SIZE	FSCM NO.	DWG NO.
B		10055, 10077, 10099
SCALE	None	SHEET 1 of 1